

**Features**

Miniature construction  
Low-Noise Output  
4.5 V to 6 V Operation  
Magnetically Optimized Package  
Linear output for circuit design flexibility  
Temperature range of -40 °C to 85 °C



3 pin SIP (suffix UA)

**Description**

SS3503 Linear Hall-effect sensor is small, versatile linear Hall-effect device that is operated by the magnetic field from a permanent magnet or an electromagnet. The linear sourcing output voltage is set by the supply voltage and varies in proportion to the strength of the magnetic field. The integrated circuitry features low

noise output, which makes it unnecessary to use external filtering. It also includes thin film resistors to provide increased temperature stability and accuracy. The linear Hall sensor has an operating temperature range of -40 °C to 85 °C appropriate for commercial, consumer and industrial environments.

**Typical Applications**

Motor control  
Magnetic code reading  
Ferrous metal detector  
Current sensing  
Position sensing

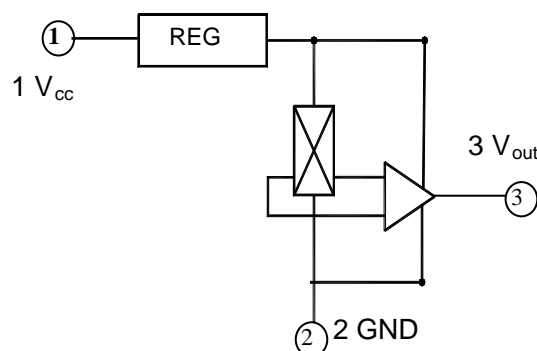
**Functional Block Diagram**

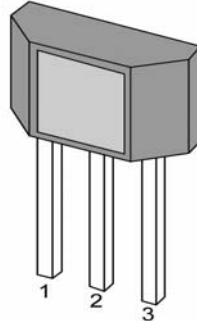
**Pins Definition****Pin Description**

Name	No	Status	Description
Vdd	1	P	Power Supply
Gnd	2	P	IC Ground
Output	3	O	Output

**Absolute Maximum Ratings**

Parameter	Symbol	Value	Units
Supply Voltage (operating)	$V_{CC}$	8.0	V
Output Current	$I_{OUT}$	20	mA
Operating Temperature Range	$T_A$	-40~85	°C
Storage Temperature Rang	$T_S$	-65~150	°C

**Electrical Characteristics (TA =25°C, VCC =5.0V)**

Parameter	Symbol	Test Conditions	Min	Typ	Max	Units
Operating voltage	V <sub>CC</sub>	Operating	3.0		6.5	V
Supply current	I <sub>CC</sub>	Average		4.2	8.0	mA
Output Current	I <sub>OUT</sub>		1.0	1.5		mA
Response Time	T <sub>ack</sub>			3		uS
Quiescent Output Voltage	V <sub>o</sub>	B=0G	2.25	2.5	2.75	V
Sensitivity	ΔV <sub>out</sub>	T <sub>A</sub> =25°C	1.6	1.8	2.0	mV/G
Min Output Voltage		B=-1500G		0.86		V
Max Output Voltage		B=1500G		4.21		V

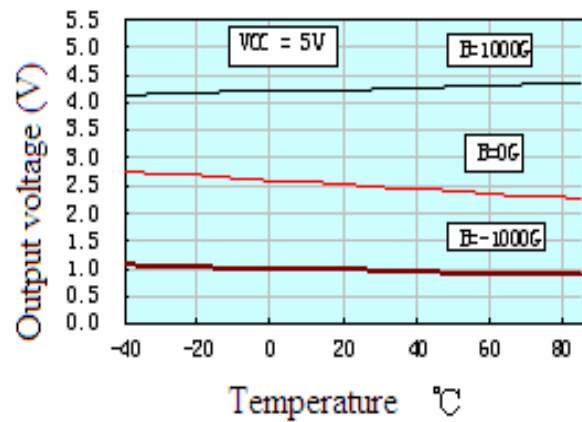
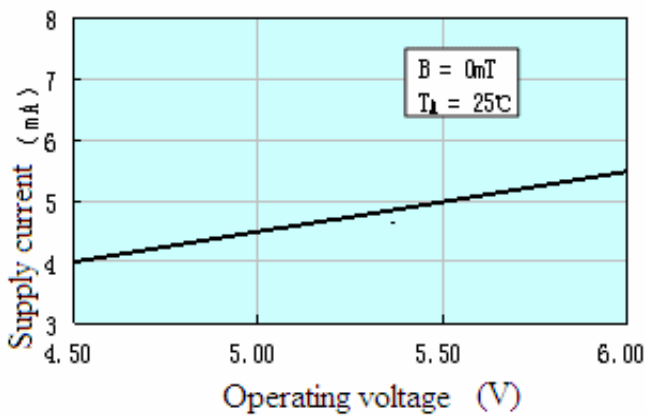
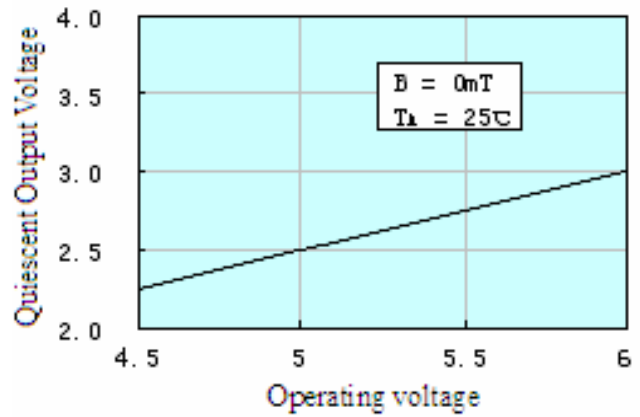
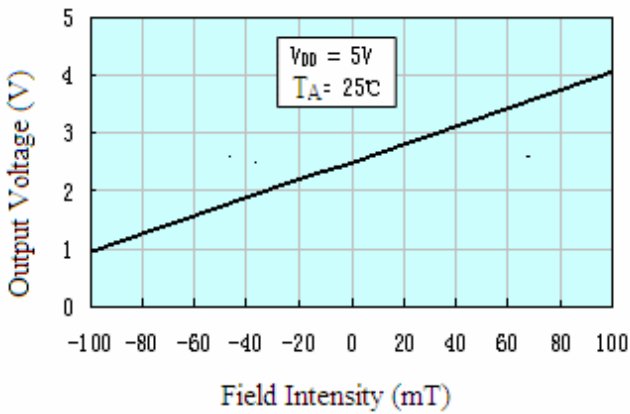
**Performance Characteristics**

### Package Information

#### Package UA, 3-Pin SIP:

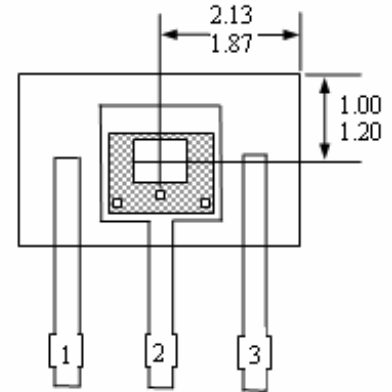
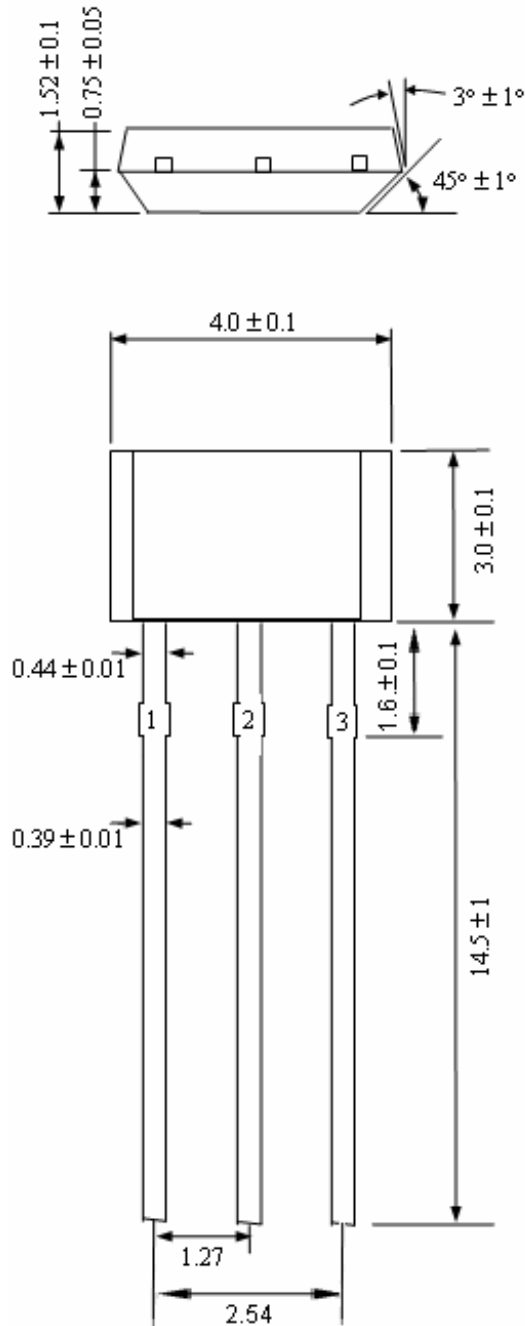

**Sensor Location**

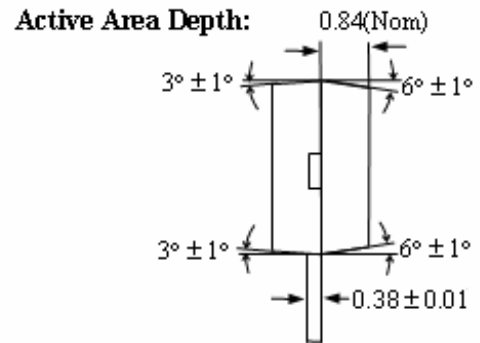

**Notes:**

- 1). Controlling dimension : mm ;
- 2). Leads must be free of flash and plating voids ;
- 3). Do not bend leads within 1 mm of lead to package interface ;
- 4). PINOUT: Pin 1 VDD  
Pin 2 GND  
Pin 3 Output

### Ordering Information

Part No.	Pb-free	Temperature Code	Package Code	Packing
SS3503EUA	YES	-40°C to 85°C	TO-92	Bulk, 1000 pieces/bag
SS3503KUA	YES	-40°C to 125°C	TO-92	Bulk, 1000 pieces/bag
SS3503LUA	YES	-40°C to 150°C	TO-92	Bulk, 1000 pieces/bag

